

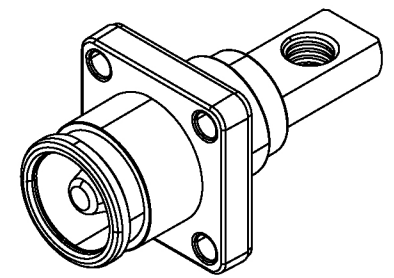

Product NO.				
ISSUE	DESCRIPTION	DWN	DATE	APPROVEN
R1.0	First issue		2020/07/01	

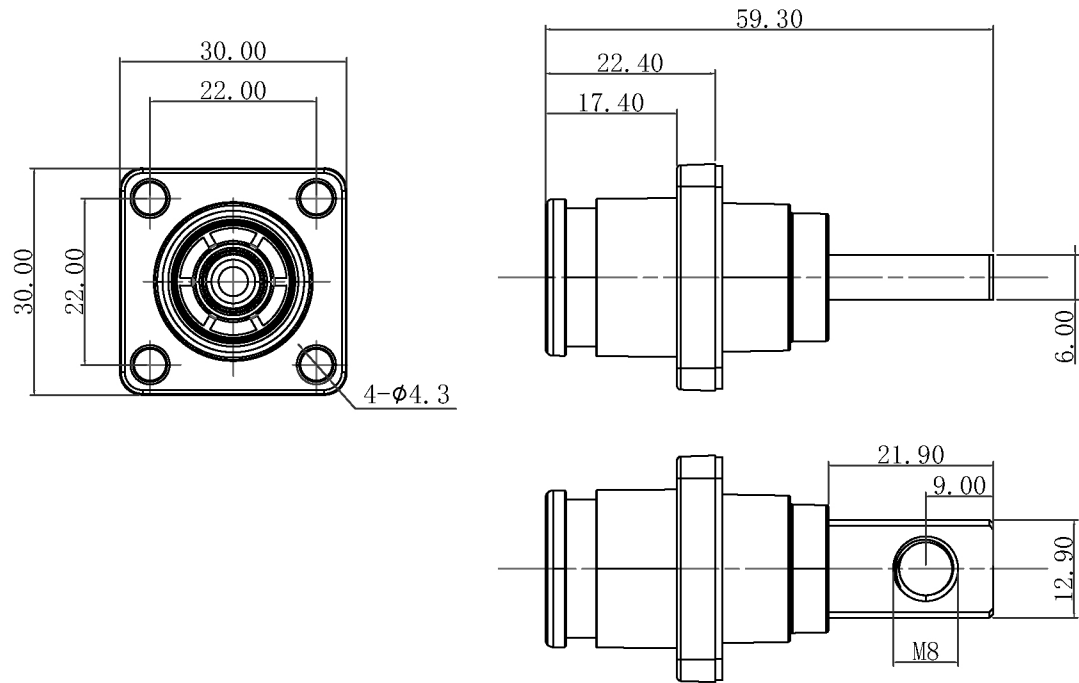

Recommended size of open board

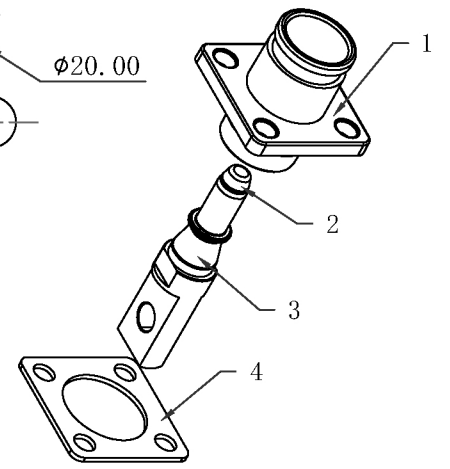
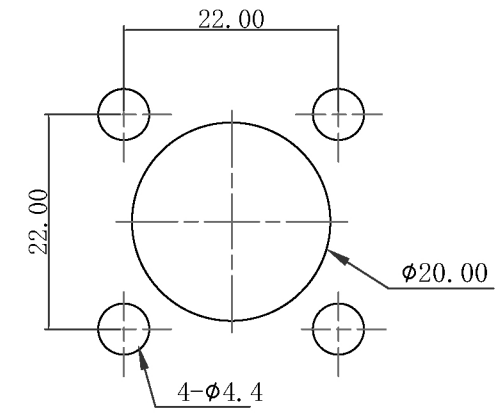

Electrical performance:  
 Rated voltage:1000V DC  
 Withstand voltage:2500V AC(1Min)  
 Temperature Rise:4hrs<40°C

Mechanical behavior:  
 Duribility:>2000 Cycles  
 M&F Holding F:>200N  
 Flame Retardant Grade:UL94-V0  
 Operating temperature:-40°C~125°C

<The product has passed CE certification>



4	Square Gasket	CR		1
3	Pin	T2	Ag	1
2	Finger Protection	PA66		1
1	Plug Shell	PA66		1
NO	Description	Material	Finish	Qty

-TOLERANCES- UNLESS OTHERWISE SPECIFIED	PART DESCRIPTION: 8mm bronze medal socket (black/orange/red)				
	P/N:				
UNLESS OTHERWISE SPECIFIED TOLERANCES FOR MILLIMETERS ARE: 0.5 - 8mm ± 0.20mm 8 - 30mm ± 0.25mm 30 - 120mm ± 0.30mm	Appr:	Date	Scale	Unit	Type
	Check:	2020.07.01	Free	MM	Z
	Draw:				1/1