

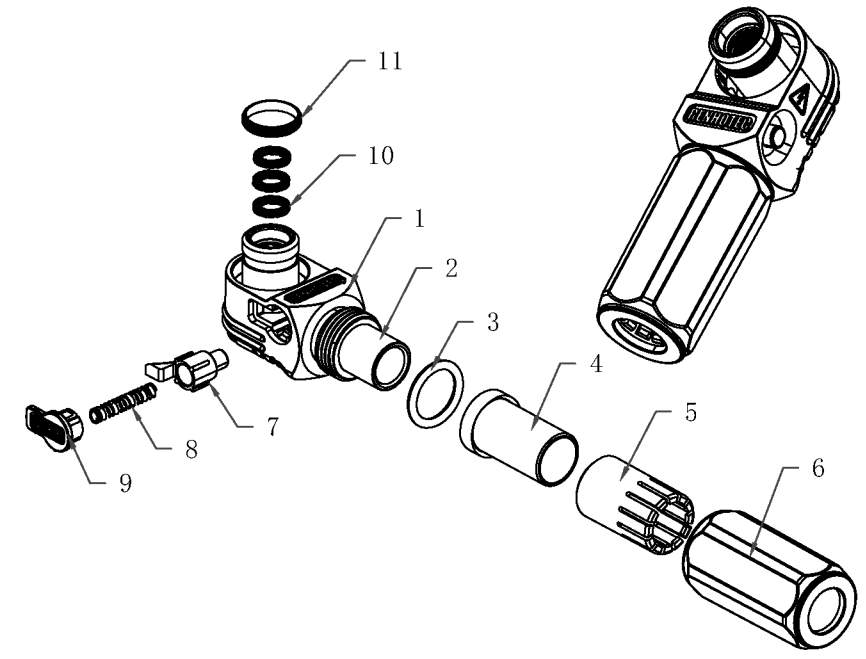

Product NO.		DWN	DATE	APPROVEN
ISSUE	DESCRIPTION			
R1.0	First issue		2020/07/01	

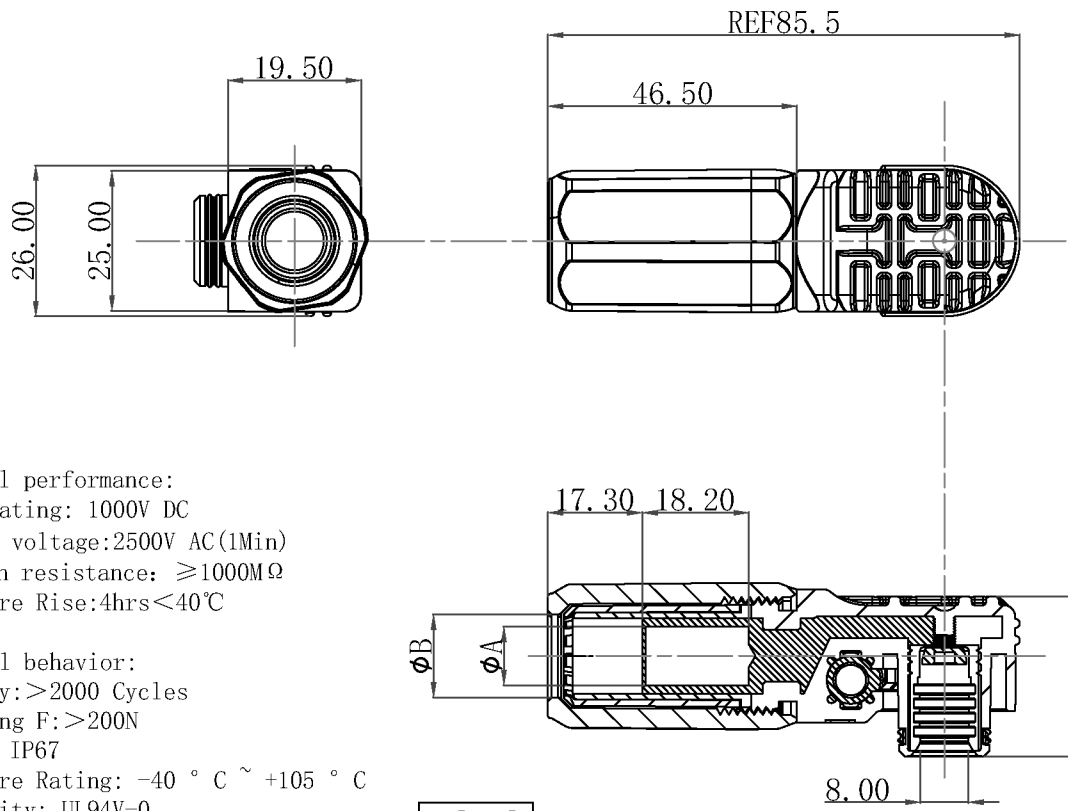

Electrical performance:
 Voltage Rating: 1000V DC
 Withstand voltage: 2500V AC (1min)
 insulation resistance: $\geq 1000M\Omega$
 Temperature Rise: 4hrs < 40°C

Mechanical behavior:
 Duribility: >2000 Cycles
 M&F Holding F: >200N
 IP Level: IP67
 Temperature Rating: -40 °C ~ +105 °C
 Flammability: UL94V-0
 <The product has passed CE certification>



Rated current	wire gage	A	B
120A	25mm ²	7.80	10.20
150A	35mm ²	9.00	11.70
200A	50mm ²	10.70	13.80

NO	Description	Material	Finish	Qty
11	Insertion Sealing	Silicone		1
10	Type 0 contact ring	C17200	Ag	3
9	Button Name	PA66		1
8	Spring	Stainless Steel		1
7	Plastic Button	PA66		1
6	Tail Cover	PA66		1
5	Cable Clamp	PA66		1
4	Rubber Sealing	Silicone		1
3	O-Ring	Silicone		1
2	Socket	T2	Ag	1
1	Receptacle Shell	PA66		1

-TOLERANCES- UNLESS OTHERWISE SPECIFIED	PART DESCRIPTION: 8mm 90 angled plug (black/orange/red)				
	P/N:				
UNLESS OTHERWISE SPECIFIED TOLERANCES FOR MILLIMETERS ARE: 0.5 - 8mm ± 0.20 mm 8 - 30mm ± 0.25 mm 30 - 120mm ± 0.30 mm	Appr:	Date	Scale	Unit	Type
	Check:	2020.07.01	Free	MM	Z
	Draw:				1/1