

REV.	DESCRIPTION	DRAWN	CHECKED	APPROVED
A	NEW RELEASE	YCH 06/20/12'		

- NOTES:**
- Materials:**
 - 1.1. Insulator: High Temperature ,UL94 V-0 Rated, RoHS,REACH compliance.
 - 1.2. Contact: Copper Alloy, Plating Matt Tin .
 - Specifications:**
 - 2.1. Temperature Range: -40~+105°C.
 - 2.2. Contact Resistance: 20mΩ maximum.
 - 2.3. Insulation Resistance: 1000MΩ minimum.
 - 2.4. Voltage Rating: 320V AC/DC.
 - 2.5. Current Rating: 9A max per pin.
 - 2.6. Application wire range:
 - 1.single solid wire: 0.2-0.75mm².
 - 2.stranded type wire: 24-18AWG.
 - 2.7. Resistance to soldering heat: 260°C,3-5seconds.
 - Product Number Code:**

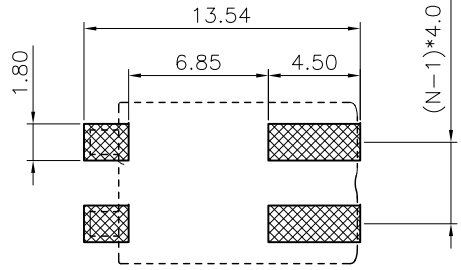
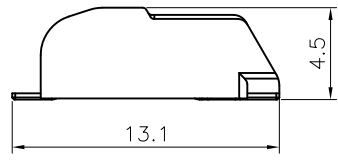
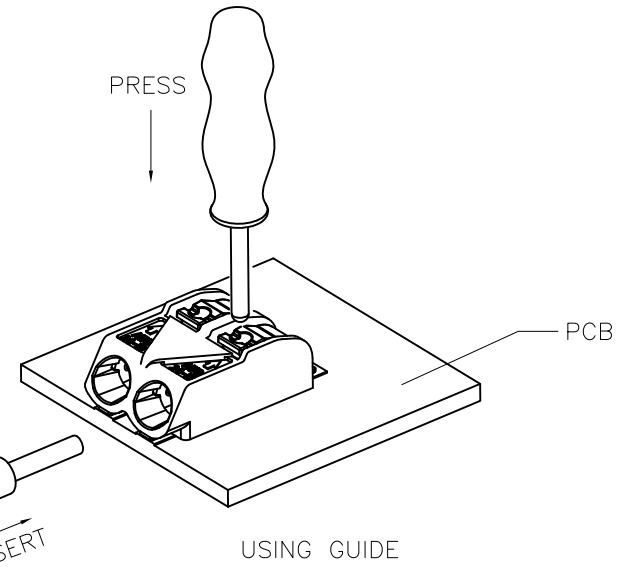
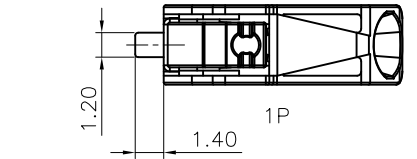
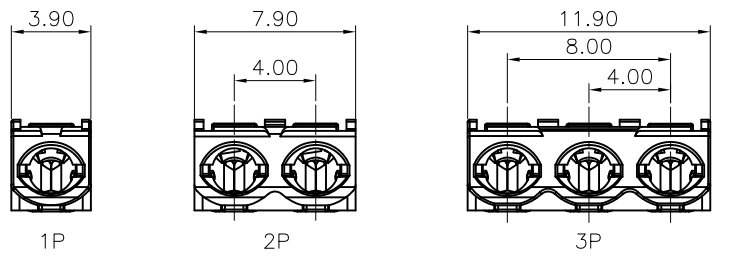
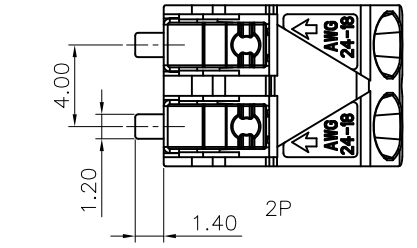
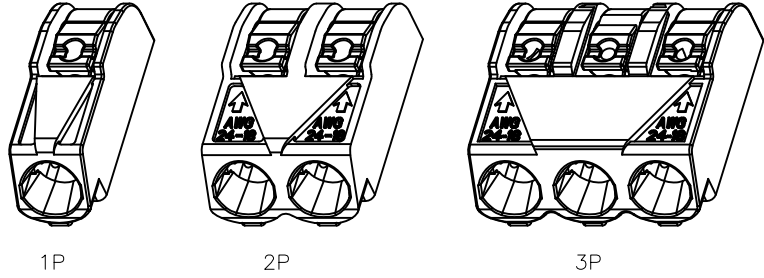
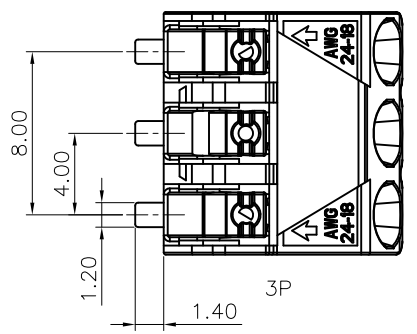

RECOMMEND PCB LAYOUT
TOLERANCE=±0.05mm

GENERAL TOLERANCE		ANGLE TOLERANCE	
X.	±0.60	X.	±5'
.X	±0.38	.X	±3'
.XX	±0.25	.XX	±2'

PROJECTION	TITLE
mm	4.00mm LED Series Terminal Block SMT Type
SHEET SIZE	SERIES SMD-452-HW-C

DRAWING TYPE	CUSTOMER
SCALE	1:1 SHEET 1 OF 1
DRAWING NO.	

